

we put solar to work™

INTRODUCTION

The M550 Solar Marine Lantern is:

- Self-contained and solar-powered
- Easy-to-install and low-maintenance with a long-life LED
- Available in red, green, white, yellow and blue
- Easy-to-maintain with replaceable AA NiMH batteries

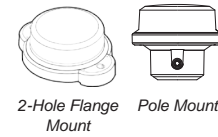

Nominal range of a lantern depends on its effective intensity and environmental conditions. For details on how to calculate range, see www.carmanahmarine.com.

APPLICATIONS

The M550 can be used for:

- 1-3 NM marine aid-to-navigation (ATON)
- Private aid-to-navigation (PATON)
- Dock & marina light
- General purpose marking light



INSTALLATION

Year-round, unrestricted solar exposure is critical to long-term performance. Shade dramatically reduces the ability of the light to charge its battery.

The M550 has changeable mounts. Ensure either the 2-hole flange mount or pole mount is attached before lantern installation.

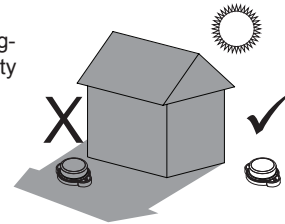

2-HOLE FLANGE MOUNT

To attach the 2-hole flange mount

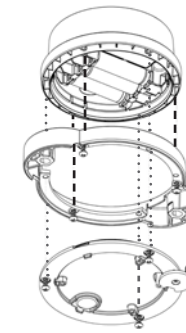

1. Use the alignment keys to align the top cover and flange mount. Press together.
2. Attach the mount to the top cover using the provided 3 screws (---). Do not over tighten!
3. Apply a thin coat of silicone lubricant to the bottom cover o-ring.
4. Align the bottom cover and press into the top cover. It only fits one way.
5. Secure the bottom cover with the provided 3 screws (.....). Do not over tighten!

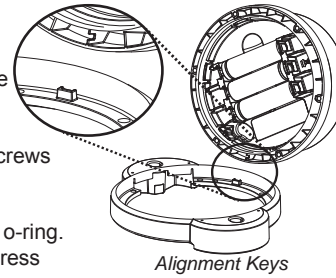

Up to 4 bird deterrents can be installed:

1. Insert the provided screw through the bird deterrent
2. Drive the screw into one of the 4 small holes on the top of the mount. Do not over tighten!
3. Bend the bird deterrent as required.

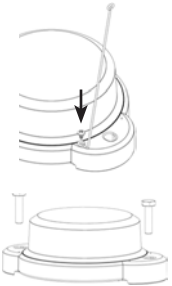

To install the lantern:

Fix in place with 2x bolts, studs & nuts, nails or screws. Recommended bolt size is 1/4-20 UNC or M6.

POLE MOUNT

Install the Pole Mount

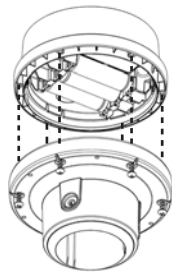

1. Apply a thin coating of silicone lubricant to the pole-mount o-ring
2. Use the alignment keys to align the top cover and pole mount.
3. Attach the mount to the top cover using the provided 6 screws. Do not over tighten!

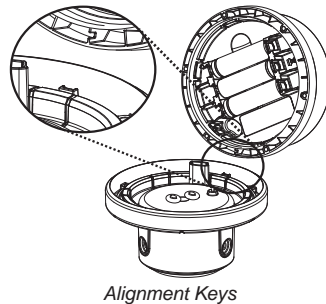

Alignment Keys

Up to 6 bird deterrents can be installed:

1. Insert a mounting screw through the bird deterrent
2. Install the screw. Do not over tighten!
3. Bend bird deterrent as needed

To install the lantern:

1. If required, insert the reducing sleeve into the pole mount. Note that it aligns only one way.
2. Slide the lantern and sleeve over the pole; press down to ensure lantern is well seated.
3. Secure with the provided 3 screws; if required, drill 1/8 - 9/64 in. [3.2 - 3.6 mm] pilot holes and then install the screws.

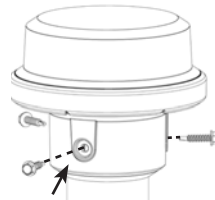

OPERATION

In daylight, the solar panel charges the battery using the Energy Management System (EMS). The capacity of the battery ensures that even with poor levels of sunlight over an extended period, the lantern has enough reserve power to continue to perform reliably. Stored battery energy then powers the LED during the night.

The change from night-to-day or day-to-night is called a transition. To avoid false transitions and ensure stable operation, the transition time is 2 minutes. For example, 2 minutes of dark is needed for the lantern to switch to night operation.



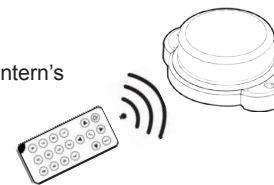

PROGRAMMING

The M550 is configured using the IR programmer. The lantern's mating IR receiver is on an energy-saving sleep cycle.

Press and hold  for 2 seconds to awaken the IR receiver and begin communication with the lantern:



The lantern is now ready to accept programming. Note that the lantern will quickly flash after every key it receives. All programming codes follow the same sequence:

     ☆☆☆ 3 quick flashes Command accepted ☆☆☆ 2 slow flashes Command rejected

The number symbol # represents 0 - 9. Commands can be rejected if they are unsupported, contain an incorrect key sequence, or have an effective intensity too high for the programmed flash code.

SETTING THE FLASH

To set the flash pattern, enter its flash code using the IR programmer. Flash codes are listed in a table at the end of this document.

Example: Enter      for quick flash Q 1s 0.3, (flash code 129)

SETTING THE INTENSITY

The M550 is programmed using Effective Intensity. Effective Intensity is the brightness of a flashing light as perceived by the human eye (as opposed to Peak Intensity which is the actual intensity of a light during a flash). Effective Intensity is calculated using the following equation:

$$\text{Effective Intensity (cd)} = \frac{\text{Peak Intensity (cd)} \times \text{Flash Duration (sec)}}{0.2 \text{ (sec)} + \text{Flash Duration (sec)}}$$

The M550 makes this calculation automatically based on your programmed flash code and Effective Intensity selected. Note that for a fixed/steady-burning light (code 001), effective intensity equals peak intensity. The range of intensity codes are:

600	0.1 - 0.4 effective cd
601	1 effective cd
602	2 effective cd
...	
6##	Maximum values vary by flash code and LED colour

Example: Enter      for intensity of 5 effective cd

 Product performance varies by installation location. Go to carmanahmarine.com/selector to determine the recommended intensity for your location.

TURNING ON/OFF

In "on" mode, the M550 LED turns on at night and off during the day. In "off" mode, the lantern charges in sunlight, but the LED remains off. When turned on again, the lantern activates at its last programmed settings (1 minute preview for daytime activations).



Option 1: Switched Models
Set the switch to on or off position

Option 2 : IR Programmer
Press and hold 4 seconds. The lantern LED will fade on or off to confirm your setting change.

CHECKING BATTERY STATE OF CHARGE (SOC)

Using the IR programmer, enter: or

Good battery SOC > 70% Charge battery SOC 14 - 70% Low battery SOC ≤ 14%, LVD Active

If the battery is ≤ 14%, Low Voltage Disconnect (LVD) disables the LED, attempts to charge the battery to a sustainable SOC. The LED is re-enabled once SOC is >75%.

AUTOMATIC LIGHT CONTROL

During periods of sustained poor solar charging, Automatic Light Control (ALC) may decrease LED intensity based on battery SOC and recent charging trends. When solar charging returns to a sustainable level, ALC increases intensity back to the user setting. ALC may be disabled to keep the lantern at a constant intensity.

Enable ALC: Disable ALC:

SPECIFICATIONS

Visit www.carmanahmarine.com for complete specifications

Temperature	-40 to 176 °F (-40 to 80 °C)	Light Source	High-power LED, >100,000 hrs lifetime
Intensity	See Flash Code table	Flash	See Flash Code table
Divergence	>8 ° FWHM Vertical Divergence	Chromaticity	IALA blue, red, white, yellow, and green
Battery	3x AA high-temperature nickel-metal hydride (NiMH), 1.2 V nominal each. -40 to 185 °F (-40 to 85 °C) ambient	Immersion	IP68, 3 ft. (1m) for 72 hrs.; EN 60529 MIL-STD-202G immersion & damp heat cycling, MIL-STD-810G rain & salt fog
Regulatory	RoHS PATON CE FCC ICES	Restriction of Hazardous Substances Directive 2002/95/EC (RoHS) Complies with the requirements of the US Coast Guard in 33 CFR, Part 66 EN 60945, EN 61000-6-1, EN 61000-6-2, EN 61000-6-3 This device complies with Part 15 of the FCC Rules (see 15.109) This Class [B] digital apparatus complies with Canadian ICES-003. Cet appareil numérique de la classe [B] est conforme à la norme NMB- 003 du Canada.	
Patents	US and International patents apply		

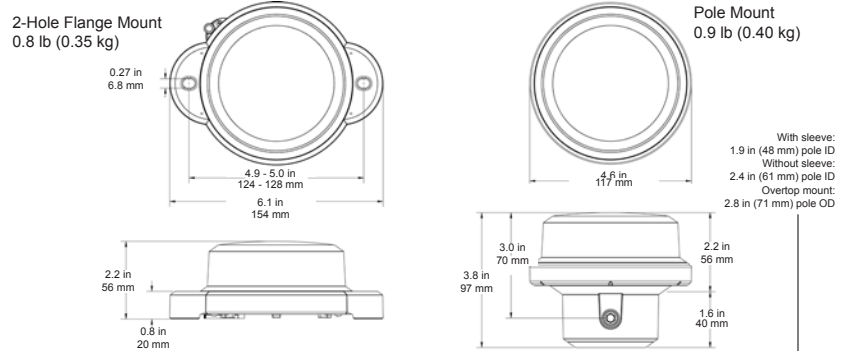

BATTERY CHARGING

The batteries are best charged inside the lantern. The M550 can recharge 0 V or 0% SOC batteries back to 100% SOC:

Summer sunlight	8-12 hours
Winter sunlight	18-36 hours
60 W incandescent lamp	15-36 hours

A commercial charger designed for 1.2 V AA batteries can also be used.



Do not use a battery charger with >370 mA charge rate. High charge rates will over heat the batteries and cause internal damage.



Take care when charging using a lamp. Provide air circulation or a fan so that lantern and batteries do not exceed max. temperature

BATTERY INSTALLATION

The M550 comes with 3x AA industrial-grade, high-temperature NiMH batteries. The M550 will only operate with all 3x batteries installed correctly. The lantern remembers its settings even when the batteries are removed.



Other rechargeable AA NiMH batteries will not void your warranty. However, shock, vibration, temperature, and optical performance may be limited.

To install batteries:

- Apply a thin coat of silicone lubricant to the large sealing o-ring
- Install batteries noting their polarity
- Align top cover and assembly components; secure with the provided screws. Do not over tighten!

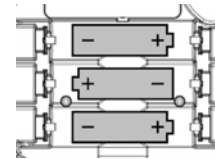

FLASH CODES

Maximum effective intensity varies by flash code and color. "FL" is the flash duration (sec) and "EC" is an eclipse (sec). Intensities are IALA values (10th percentile) over a 360° horizontal measurement.

Flash Code	Flash Character	FL1	EC1	FL2	EC2	FL3	EC3	FL4	EC4	FL5	EC5	Duty Cycle	Maximum Effective Intensity (cd)				
													White	Yellow	Green	Red	Blue
000	off	0	0									0%	0	0	0	0	0
001	F	60	0									100%	29	25	23	18	8
012	Fl(2) 6s 0.5	0.5	1	0.5	4							16.7%	20	17	17	12	6
016	Fl(2) 8s 0.5	0.5	1	0.5	6							12.5%	20	17	17	12	6
043	Fl 1.5s 0.5	0.5	1									33.3%	20	17	17	12	6
044	Fl 10s 0.5	0.5	9.5									5%	20	17	17	12	6
049	Fl 2.5s 0.3	0.3	2.2									12%	17	15	14	10	5
050	Fl 2.5s 0.5	0.5	2									20%	20	17	17	12	6
051	Fl 2.8s 0.3	0.3	2.5									10.7%	17	15	14	10	5
052	Fl 2s 0.2	0.2	1.8									10%	14	12	11	9	4
055	Fl 2s 0.5	0.5	1.5									25%	20	17	17	12	6
058	Fl 3s 0.3	0.3	2.7									10%	17	15	14	10	5
059	Fl 3s 0.5	0.5	2.5									16.7%	20	17	17	12	6
060	Fl 3s 0.7	0.7	2.3									23.3%	22	19	18	14	6
061	Fl 3s 1.0	1	2									33.3%	24	20	19	15	7
063	Fl 4.4s 0.4	0.4	4									9.1%	19	16	15	12	5
064	Fl 4s 0.5	0.5	3.5									12.5%	20	17	17	12	6
066	Fl 4s 1.0	1	3									25%	24	20	19	15	7
068	Fl 5s 0.3	0.3	4.7									6%	17	15	14	10	5
069	Fl 5s 0.5	0.5	4.5									10%	20	17	17	12	6
070	Fl 5s 1.0	1	4									20%	24	20	19	15	7
072	Fl 6s 0.5	0.5	5.5									8.3%	20	17	17	12	6
078	iso 2s	1	1									50%	24	20	19	15	7
079	iso 4s	2	2									50%	26	22	21	16	7
098	Mo(U) 10s 0.3	0.3	0.7	0.3	0.7	0.9	7.1					15%	17	15	14	10	5
099	Mo(U) 10s 0.4	0.4	0.6	0.4	0.6	1.2	6.8					20%	19	16	15	12	5
103	Mo(U) 15s 0.7 0.5	0.5	0.5	0.7	0.5	1.9	10.7					22%	22	19	18	14	6
104	Mo(U) 15s 0.7 0.7	0.7	0.7	0.7	0.7	2.1	10.1					23.3%	22	19	18	14	6
125	Q 1.2s 0.3	0.3	0.9									25%	17	15	14	10	5
126	Q 1.2s 0.5	0.5	0.7									41.7%	20	17	17	12	6
129	Q 1s 0.3	0.3	0.7									30%	17	15	14	10	5
131	Q 1s 0.5	0.5	0.5									50%	20	17	17	12	6
144	Q(4) 20s 0.5	0.5	0.5	0.5	0.5	0.5	0.5	0.5	0.5	16.5		10%	20	17	17	12	6
147	Q(5) 20s 0.3	0.3	0.7	0.3	0.7	0.3	0.7	0.3	0.7	0.3	15.7	7.5%	17	15	14	10	5
160	VQ 0.6s 0.3	0.3	0.3									50%	17	15	14	10	5
174	Fl 4s 0.4	0.4	3.6									10%	19	16	15	12	5
178	Fl (3+1) 20s 0.5	0.5	1.5	0.5	1.5	0.5	4.5	0.5	10.5			10%	20	17	17	12	6
179	Fl (3+1) 20s 0.6	0.6	1.4	0.6	1.4	0.6	4.4	0.6	10.4			12%	21	18	17	13	6
209	Q 1s 0.15	0.15	0.85									15%	12	10	10	7	3
238	CST9	0.6	0.3	0.6	0.3	1.5	56.7					4.5%	21	18	17	13	6
251	Fl 3.5s 0.7	0.7	2.8									20%	22	19	18	14	6

STORAGE

Turn the lantern off to store. In switched models, set the switch to the "off" position. To turn off using the IR programmer, press and hold for 4 seconds.

- If a lantern detects continuous dark for 24 hrs, it will disable the LED. Upon sensing light, it will enable the LED and continue normal operation
- Check the battery state of charge every 1 - 2 months and charge if required
- High-grade NiMH batteries shipped with the M550 can be stored without any charging for up to 12 months with no battery damage

TROUBLESHOOTING

LED is off during the night	Batteries are very low and lantern cannot turn on	Charge the lantern or replace the batteries
	Batteries are low and LVD is active	Confirm with code 810 using IR programmer. Charge lantern or replace batteries. Decrease eff. intensity to a sustainable level
	Switch is off	Switch to on
	Night not yet detected	Wait for the lantern to detect 2 min. of consistent "dark"
	Nearby light source is illuminating the lantern	Move away from light source, turn off unneeded light, or shield lanterns
No response to IR programmer	Solar panel is not charging the battery well during the day	Under bright sunlight, enter code 815 using the IR programmer: 1x flash= too low for charging, 2x flashes = solar panel is fine
	Batteries are very low and lantern cannot turn on	Charge the lantern or replace the batteries
Moisture inside	Sunlight is obscuring IR signal	Move the IR programmer closer to the lantern
	Condensation	Ensure the vent on the bottom cover is not dirty or obstructed
	Seal failure	Ensure the bottom cover o-ring is dry (no water) and lubricated. Ensure o-ring is not pinched and all screws are fully installed

MAINTENANCE

Although the M550 is maintenance-free, performance gains can be made. Clean with water and a soft sponge or cloth. A mild non-abrasive cleanser can be used for more stubborn residue. Clean more frequently during drier months as dust accumulates more quickly. Check the exterior and o-rings for cracks, missing or broken hardware.

RECYCLING

This product may contain substances that could be harmful to the environment or human health if improperly handled at the product's end of life. Check your local municipality for electronics recyclers.



The batteries are rechargeable nickel-metal hydride (NiMH). Consult your local laws for information on recycling.



This product complies with the European Union's requirements according to Directive 2002/96/EC on waste electrical and electronic equipment (WEEE).

WARRANTY

This product is covered by the Carmanah warranty. Failure to comply with the use, storage, maintenance, or installation instructions detailed in this manual could void the warranty. Changes or modifications not expressly approved by the party responsible for compliance could void the user's authority to operate the equipment.

Email: customerservice@carmanah.com
Toll Free: 1.877.722.8877 (US & Canada)
Worldwide: 1.250.380.0052
Fax: 1.250.380.0062
Web: carmanah.com